

TECHNICAL INFORMATION

POSITIONING SYSTEMS



Information in this document is subject to change. Owing to continued product development, Rollco reserves the right to make alterations without prior notice. Every care has been taken to ensure the accuracy of the information, but no liability can be accepted for any errors or omissions.

All information and content included in this document, such as text, and images, are property of Rollco. Any reproduction, even partial, is allowed only by written permission by Rollco.

Index

GENERAL INFORMATION	4
Product overview	4
TECHNICAL INFORMATION	5
The PSD series	5
The PSE/PSS/PSW series	6
Compare the systems	9
Automatic format changes	10
Finding the right product	11
Performance curves	11
Calculate the torque	12
For dry, damp or wet areas	12
The appropriate bus system for your machine	13
ORDER CODE	14
Positioning System PSD	14
Positioning System PSE/PSS/PSW	16

Product overview



Machines and plants require minimal set-up times and consequently automation of the re-positioning can be advisable. Manufacturers demand high flexibility when it comes to adjusting the production line to different products. When a machine is converted, many objects are positioned on adjustment axes, for example guides, rails, labelers, vision system cameras etc. Our positioning systems adjust these axes to the new position instantly by demand – efficiently and precisely.

In our range we offer two different systems, the PSD- and the PSE/PSS/PSW-series. The PSE/PSS/PSW devices are interchangeable in terms of connection dimensions, but provide different IP protection classes. All positioning systems have compact structure and are available in both horizontal and vertical design.

They include motor, gearbox, absolute encoder and motor control system with a variety of different bus communications along with a wide range of designs and performance characteristics. The PSD direct drives are equipped with stepmotor and the PSE/PSS/PSW brushless EC-motor.

Both systems offer time-saving benefits with adjustment of several axis at the same time. Also, the set up time of the system or a replacement is minimal. The absolute measuring system eliminates the need for time-consuming reference runs and increases the efficiency of the machine. The positioning system always knows its exact position and has 100% repeatability accuracy.

A self-monitoring system accurately detects unwanted changes in position and immediately corrects and re-sets the desired position. Thanks to self-analysis and early warnings, the positioning systems provide support for predictive maintenance – to improve your machine's availability.

The galvanically separated supply voltages for the control and performance electronics permit the implementation of an emergency shut-off function without interrupting communication with the control module. During an emergency stop it is still possible to read the status and current actual position, which means that you can avoid positioning errors even if the power supply is interrupted.

Application areas

The positioning devices are typically used in machines for:

- Labelling
- Filling and bottling
- Packaging
- Shearing
- Gluing and sealing
- Wood working

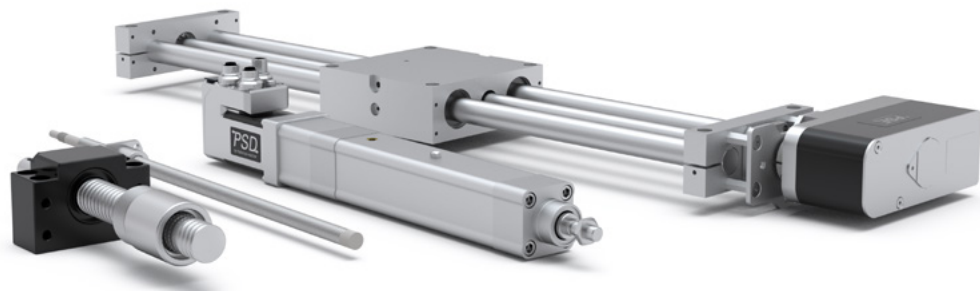

The positioning systems are ideal for our PNCE Electromechanical Cylinders and Linear Units QME. Compact solutions are easily engineered using ball screw arrangements.

The PSD series

The PSD direct drives are mechatronic systems with integrated control, bus interface and absolute measurement system without battery. The stepper motor with integrated control and bus communication permits higher velocities at lower torques. This closes the gap on servo drives with regulators. PSD offers a significantly more compact design and simpler wiring as they eliminate the need for an external controller - a cost-effective solution for format changeovers.

The PSD can be easily addressed by rotary switches (not for IO-Link). The unit can be mounted on a spindle using the hollow shaft without the need for an additional coupling. The direct drive is available in both horizontal and vertical design. The optional rotatable attachment housing allows you to attach the direct drives to the machine in any position.



Functions

- Rotary switch for easy addressing of the device (not for IO-Link).
- Optional rotatable housing for attachment in any position.
- No brake required (depending on the application).
- Also available as 1-connector solution (IO-Link).
- Self-monitoring functions covering current, voltage, temperature, and step monitoring with correction for errors.
- Bus communication CANopen, IO-Link, PROFINET, EtherCAT and EtherNet/IP.
- Software features, for example spindle offset run, increased breakaway torque, synchronized run.
- Software modules for IO-Link: changeover of parameter set, target speed in process data and modulo function

PSD range

Models	Type	Output shafts	Nominal torque	Nominal rated speed
PSD 40	Horizontal	<ul style="list-style-type: none"> • 5 mm solid shaft • 8 mm hollow shaft • 14 mm hollow shaft 	0,8 .. 3 Nm	200 .. 50 rpm Peak at 800 rpm
PSD 41	Vertical	<ul style="list-style-type: none"> • 5 mm solid shaft • 8 mm hollow shaft • 14 mm hollow shaft 	0,8 .. 3 Nm	200 .. 50 rpm Peak at 800 rpm
PSD 42	Horizontal	<ul style="list-style-type: none"> • 8 mm solid shaft • 8 mm hollow shaft • 14 mm hollow shaft 	2 .. 8 Nm	200 .. 50 rpm Peak at 1000 rpm
PSD 43	Vertical	<ul style="list-style-type: none"> • 8 mm solid shaft • 8 mm hollow shaft • 14 mm hollow shaft 	2 .. 8 Nm	200 .. 50 rpm Peak at 1000 rpm

Visit our website for product specifications and detailed technical data.

The PSE/PSS/PSW series

The PSE/PSS/PSW positioning systems are intelligent, compact solutions for the automatic adjustment of auxiliary and positioning axis. The product range has high quality brushless EC-motors, which do not wear and drive the positioning system accurately. The integrated electronic control feature frees up the machine’s central control unit. No external motors, proximity or limit switches are required.

Address and baud rate switches simplify start-up. The instruments can be mounted on a spindle using the hollow shaft without the need for an additional coupling. Rotative positioning systems for adjusting positioning and auxiliary axis make your production processes more efficient – faster adjustment, fewer standstills and lower rejection rates from the machine.

The three types have different protection classes but interchangeable in terms of their connection dimensions.

- PSE – Protection class IP 54
- PSS – Protection class IP 65 (Stainless steel housing)
- PSW – Protection class IP 68 (Washable)

Functions

Easy address assignment directly on the device using integrated address switches (not for IO-Link). Intelligent running behaviour. Recognises the difference between obstacles and dirt. Self-monitoring functions such as condition monitoring of supply voltage, drag error (permits optimum adjustment of current position), power consumption and torque. 10 types of Bus communication systems. Software features, for example spindle offset run, limiting torque, synchronized run. Fast and simple set up with jog keys as add-on option and address selection switches.

Safe torque off (STO)

The PSE/PSS/PSW-series have a partial safety function for STO. The function corresponds to an emergency stop function. When STO is activated the positioning system actively generates no more torque. To fulfil the safety function, further components are required.

Levels of STO signals

- STO low <5V ⇒ STO is activated (e.g. ground/0V)
- STO high >15V ⇒ Normal working condition (e.g. 24 VDC/ower supply)



If STO is activated the system does not receive any drive commands.



PSE range

Models	Type	Output shafts	Nominal torque	Nominal rated speed
PSE 30	Horizontal	<ul style="list-style-type: none"> • 8 mm hollow shaft • 14 mm hollow shaft 	1 .. 5 Nm	210 .. 40 rpm
PSE 31	Vertical	<ul style="list-style-type: none"> • 8 mm hollow shaft • 14 mm hollow shaft 	1 .. 5 Nm	210 .. 40 rpm
PSE 32	Horizontal	<ul style="list-style-type: none"> • 14 mm hollow shaft 	1 .. 18 Nm	210 .. 17 rpm
PSE 33	Vertical	<ul style="list-style-type: none"> • 14 mm hollow shaft 	1 .. 25 Nm	210 .. 10 rpm
PSE 34	Horizontal	<ul style="list-style-type: none"> • 14 mm hollow shaft 	10 .. 18 Nm	60 .. 80 rpm

PSS range







Models	Type	Output shafts	Nominal torque	Nominal rated speed
PSS 30	Horizontal	<ul style="list-style-type: none"> • 8 mm solid shaft • 8 mm hollow shaft • 14 mm solid shaft • 14 mm hollow shaft 	1 .. 5 Nm	210 .. 40 rpm
PSS 31	Vertical	<ul style="list-style-type: none"> • 8 mm solid shaft • 8 mm hollow shaft • 14 mm solid shaft • 14 mm hollow shaft 	1 .. 5 Nm	210 .. 40 rpm
PSS 32	Horizontal	<ul style="list-style-type: none"> • 14 mm solid shaft • 14 mm hollow shaft 	1 .. 18 Nm	210 .. 17 rpm
PSS 33	Vertical	<ul style="list-style-type: none"> • 14 mm solid shaft • 14 mm hollow shaft 	1 .. 5 Nm	210 .. 68 rpm

PSW range

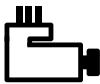

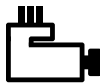

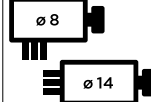



Models	Type	Output shafts	Nominal torque	Nominal rated speed
PSW 30	Horizontal	<ul style="list-style-type: none"> • 8 mm solid shaft • 8 mm hollow shaft • 14 mm solid shaft • 14 mm hollow shaft 	1 .. 5 Nm	180 .. 35 rpm
PSW 31	Vertical	<ul style="list-style-type: none"> • 8 mm solid shaft • 8 mm hollow shaft • 14 mm solid shaft • 14 mm hollow shaft 	1 .. 5 Nm	180 .. 35 rpm
PSW 32	Horizontal	<ul style="list-style-type: none"> • 14 mm solid shaft • 14 mm hollow shaft 	1 .. 18 Nm	180 .. 14 rpm
PSW 33	Vertical	<ul style="list-style-type: none"> • 14 mm solid shaft • 14 mm hollow shaft 	1 .. 5 Nm	180 .. 50 rpm

Visit our website for product specifications and detailed technical data.

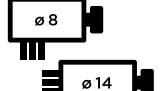
Compare the systems

	PSD 40	PSD 41	PSD 42	PSD 43	PSE 30	PSE 31	PSE 32	PSE 33
Type	Horizontal 	Vertical 	Horizontal 	Vertical 	Horizontal 	Vertical 	Horizontal 	Vertical 
Protection class	IP 50 (optional IP 65)				IP 54 (optional IP 65)			
Bus communication ³⁾	CA, EC, PN, IO, EI				CA, DP, DN, MB, SE, EC, PN, EI, PL, IO			
Motor	Step motor				EC-motor			
Intermittance	Start-up duration up to 50%		Start-up duration up to 30%		30 % (basis time 300 s)			25 % (basis time 300 s)
Nominal torque	0,8 .. 3 Nm	0,8 .. 3 Nm	2 .. 8 Nm	2 .. 8 Nm	1 .. 5 Nm	1 .. 5 Nm	1 .. 18 Nm	1 .. 25 Nm
Self-holding torque	1/2 nominal torque				0.5 .. 12.5 Nm			
Nominal rated speed	200 .. 50 rpm Peak at 800/1000 rpm				210 .. 40 rpm		210 .. 17 rpm	210 .. 10 rpm
Nominal voltage	24 VDC (± 10 %) Galvanically separated supply voltages between control and motor and bus							
Nominal current (A)	2.0 A		4.0 A		PSE30_-8 2.2 A PSE30_-14 2.4 A PSE 31_-8 2.2 A PSE 31_-14 2.4 A	3.1 A		
Output shaft	5 mm solid shaft 8 mm hollow shaft 14 mm hollow shaft		8 mm solid shaft 8 mm hollow shaft 14 mm hollow shaft		8 mm hollow shaft 14 mm hollow shaft		14 mm hollow shaft	
Measurement system ⁵⁾	Absolute without battery				Absolute, optical-magnetic			
Positioning range	986 .. 4026 rotations		977 .. 4026 rotations		250 rotations ⁶⁾			
Jog keys	No				Optional via jog key contacts ⁷⁾			
Accuracy	± 0.7° for versions with gearbox ± 1.8° for versions without gearbox				± 0.9°			
Manual adjustment	No				Standard, only possible with 14 mm output shaft			
Brake ⁹⁾	No				Optional (holding brake) for 14 mm output shaft			
STO	No				Yes			

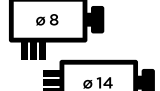
- ¹⁾ Under installed and wired conditions
- ²⁾ IP 68 at standstill, IP 66 during rotation (tested with water)
- ³⁾ See p. 13 for bus abbreviations
- ⁴⁾ With current
- ⁵⁾ Generally without battery, therefore maintenance-free
- ⁶⁾ Without mechanical limitation
- ⁷⁾ Not for PSW or IO-Link, always via an extra connector
- ⁸⁾ Not for CANopen
- ⁹⁾ Please contact us for brake selection

PSE 34	PSS 30	PSS 31	PSS 32	PSS 33	PSW 30	PSW 31	PSW 32	PSW 33
Horizontal 	Horizontal 	Vertical 	Horizontal 	Vertical 	Horizontal 	Vertical 	Horizontal 	Vertical 
IP 65	IP 65 ¹⁾				IP 68 ²⁾			
CA, DP, SE, EC, PN, EI, PL, IO	CA, DP, DN, MB, SE, EC, PN, EI, PL, IO				CA, DP, DN, MB, SE, EC, PN, EI, PL, IO			
EC-motor	EC-motor				EC-motor			
20% (basis time 300 s)	20 % (basis time 600 s)				20 % (basis time 600 s)			
10 .. 18 Nm	1 .. 5 Nm	1 .. 5 Nm	1 .. 18 Nm	1 .. 5 Nm	1 .. 5 Nm	1 .. 5 Nm	1 .. 18 Nm	1 .. 5 Nm
5 .. 9 Nm ⁴⁾	0.5 .. 9 Nm				0.5 .. 9 Nm			
60 .. 80 rpm	210 .. 40 rpm	210 .. 17 rpm	210 .. 68 rpm	180 .. 35 rpm	180 .. 14 rpm	180 .. 50 rpm		
24 VDC (± 10 %) Galvanically separated supply voltages between control and motor and bus								
7.8 A	PSS 30_-8 2.2 A PSS 30_-14 2.4 A PSS 31_-8 2.2 A PSS 31_-14 2.4 A	PSS 32_-14 3.1 A PSS 3210-14 2.2 A PSS 3218-14 2.2 A PSS 33_-14 3.1 A	PSW 30_-8 2.2 A PSW 30_-14 2.4 A PSW 31_-8 2.2 A PSW 31_-14 2.4 A	PSW 32_-14 3.1 A PSW 3210-14 2.2 A PSW 3218-14 2.2 A PSW 33_-14 3.1 A				
14 mm hollow shaft	8 mm solid shaft 8 mm hollow shaft 14 mm solid shaft 14 mm hollow shaft	14 mm solid shaft 14 mm hollow shaft	8 mm solid shaft 8 mm hollow shaft 14 mm solid shaft 14 mm hollow shaft	14 mm solid shaft 14 mm hollow shaft				
Absolute, optical-magnetic	Absolute, optical-magnetic				Absolute, optical-magnetic			
250 rotations ⁶⁾	250 rotations ⁶⁾				250 rotations ⁶⁾			
Optional via jog key contacts ⁸⁾	Optional via jog key contacts ⁷⁾				Optional via jog key contacts ⁷⁾			
± 0.9°	± 0.9°				± 0.9°			
Standard	Standard, only possible with 14 mm output shaft				Standard, only possible with 14 mm output shaft			
Optional (friction brake)	Optional (holding brake) for 14 mm output shaft				Optional (holding brake) for 14 mm output shaft			
Yes	Yes				Yes			



Automatic format changes

These days machines and plants require minimal set-up times. Conversion is therefore automated more often.

More and more bottlers are, for instance, demanding high flexibility when it comes to changing bottle formats. Example; after small round ones, a quick changeover must be made to tall square bottles.

When a machine is converted, many objects are positioned on adjustment axes in the entire process: guide rails, labelers and inspection cameras. Our positioning systems adjust these axes to the new position in the control unit immediately after the demand - quickly and precisely.

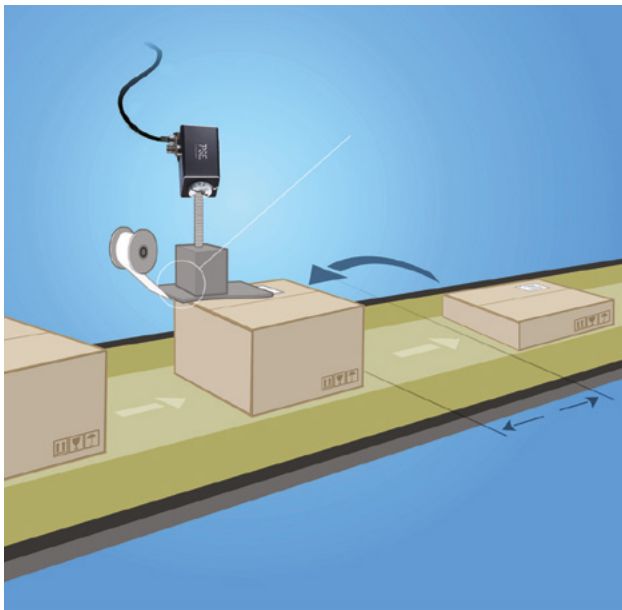

Gain time and avoid errors with automated changeovers

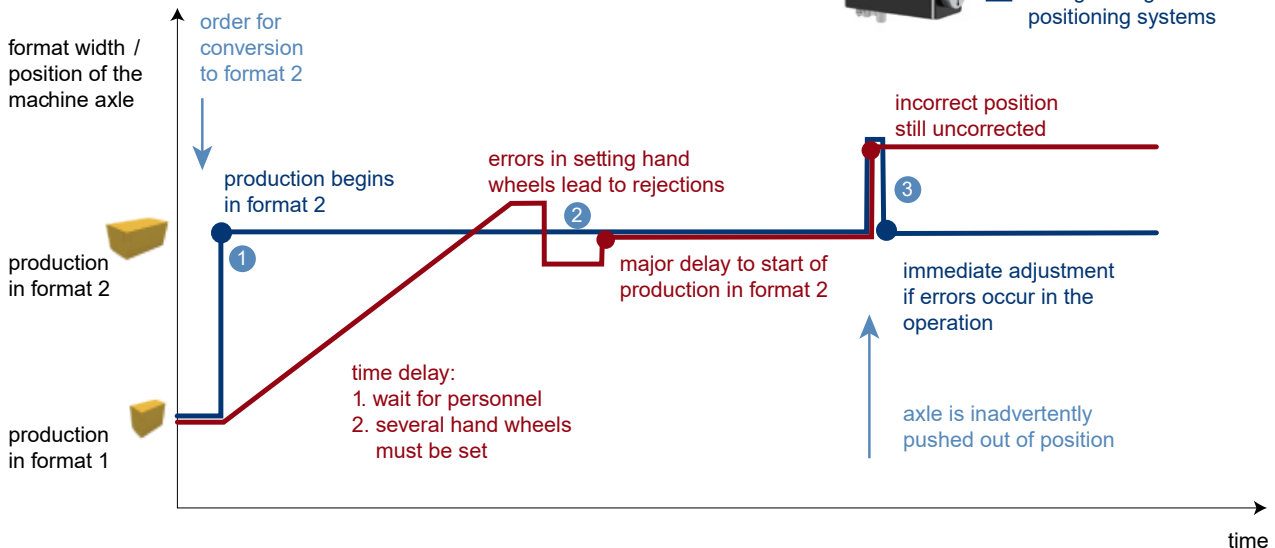

Finding the right product

Performance curves

The positioning systems cover a performance range which is ideal for frequent format changes. If you already know your torque / speed range and these performance curves can help you select the appropriate model.

Please note that the performance curves show the nominal torque/nominal rated speed combinations for the different positioning systems. They are intended to provide an initial guide and enable you to find the correct positioning systems based on the required torque range.

PSD-series

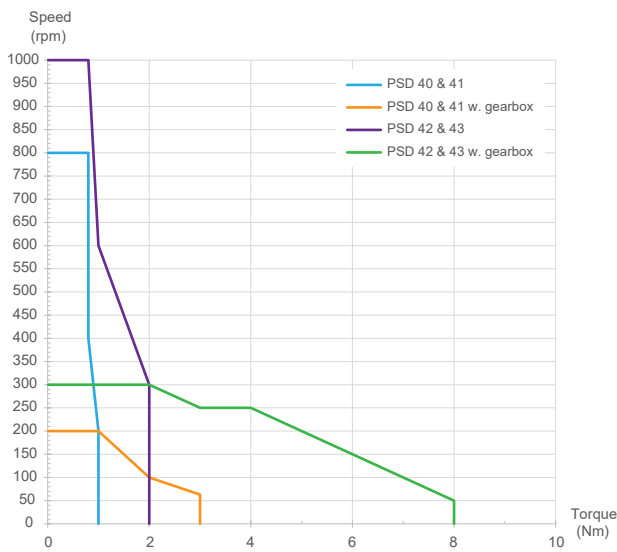

PSE-series

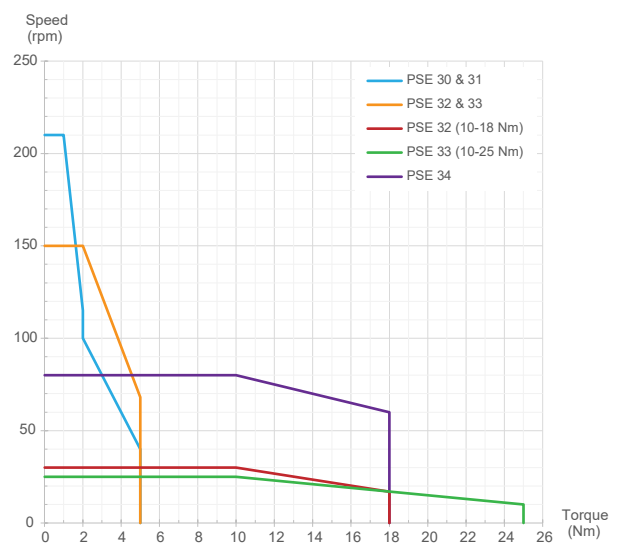

PSS-series

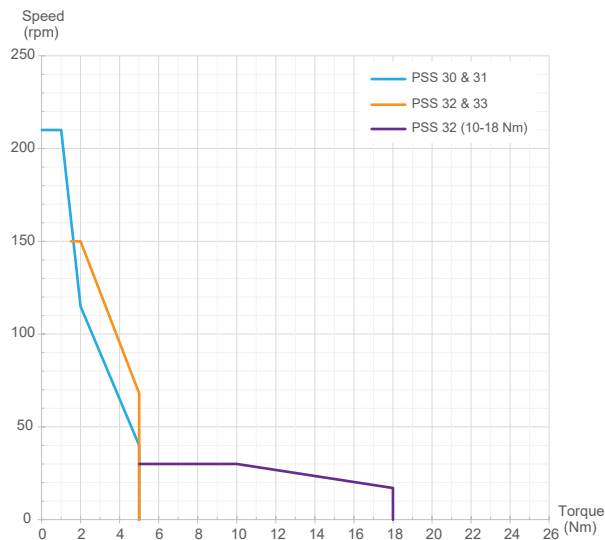

PSW-series

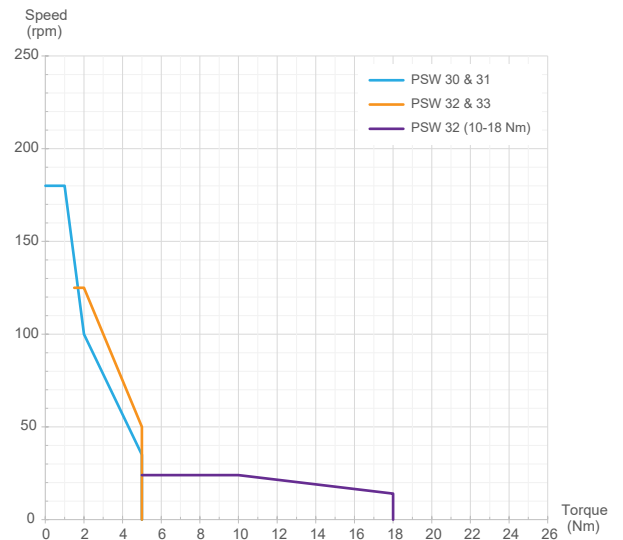

Calculate the torque

Do you know the mass to be positioned and are looking for the appropriate torque when making a vertical adjustment? The following calculation allows you to calculate the approx. torque required. Note that it does not consider the torque requirement by friction in sliding parts.

$$\text{Torque } M \text{ [Nm]} = \frac{m \text{ [kg]} \times s \text{ [mm]}}{630} \times T$$

(if unknown)

- m = Mass
- s = Spindle pitch
- T = 1.1 for ball screw spindle
- T = 3.3 for trapezoidal threaded spindle

Example:

Mass: 50 kg
 Spindle pitch: 4 mm,
 Trapezoidal threaded spindle

$$\text{Torque } M \text{ [Nm]} = \frac{50 \text{ kg} \times 4 \text{ mm}}{630} \times 3.3 \text{ Nm} = 1.04 \text{ Nm}$$

Result:

A positioning system with 2 Nm torque should be selected. (30% reserve).

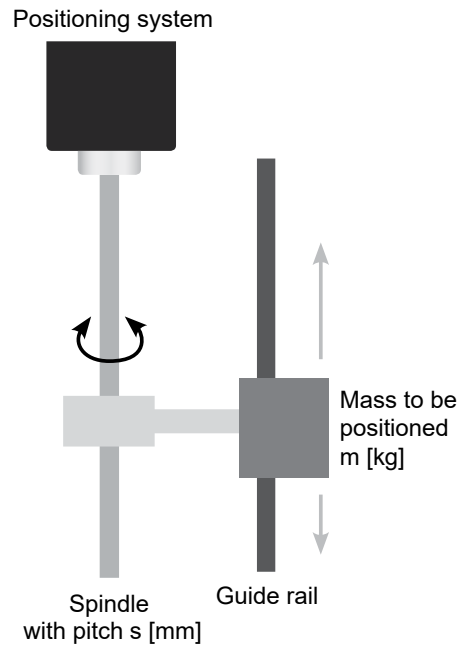

For dry, damp or wet areas

Many machines are used under normal manufacturing conditions and therefore require no additional moisture protection for the positioning system. Good resistance to dust is far more important. For applications such as these, standard devices with the protection class IP 54 are an ideal solution.

Hygienic applications in the food processing and pharmaceutical sectors as well as other critical applications require a higher protection class. This is achieved by using more resistant materials (e.g. stainless steel) and suitably designed seals. These measures are relevant to the overall cost of the solutions, so we offer devices in both the IP 65 and IP 68 segments.

Protection Class	PSD-series	PSE-series	PSS-series	PSW-series
IP 50	Standard	-	-	-
IP 54	-	Standard	-	-
IP 65	Optional	Optional	Standard	-
IP 68	-	-	-	Standard

The appropriate bus system for your machine

To be able to offer a high level of flexibility in the range of bus communication standards to meet the wishes of the machine's user.

Bus communication	PSD-series	PSE-series	PSS-series	PSW-series
CANopen (CA)	Yes	Yes	Yes	Yes
PROFIBUS (DP)	No	Yes	Yes	Yes
DeviceNet (DN)	No	Yes	Yes	Yes
Modbus RTU (MB)	No	Yes	Yes	Yes
Sercos (SE)	No	Yes	Yes	Yes
EtherCAT (EC)	Yes	Yes	Yes	Yes
PROFINET (PN)	Yes	Yes	Yes	Yes
EtherNet/IP (EI)	Yes	Yes	Yes	Yes
POWERLINK (PL)	No	Yes	Yes	Yes
IO-Link (IO)	Yes	Yes	Yes	Yes

Mechanical adaptations with minimal effort

The output shaft of the positioning system has to be adapted to the application. A hollow shaft with an adjustable collar has proven itself an effective and reliable solution for this task. Torque support is also very easily implemented using a pin. This eliminates the need for a coupling with intermediate flange. This saves additional costs, assembly time and space.

Mounting with hollow shaft

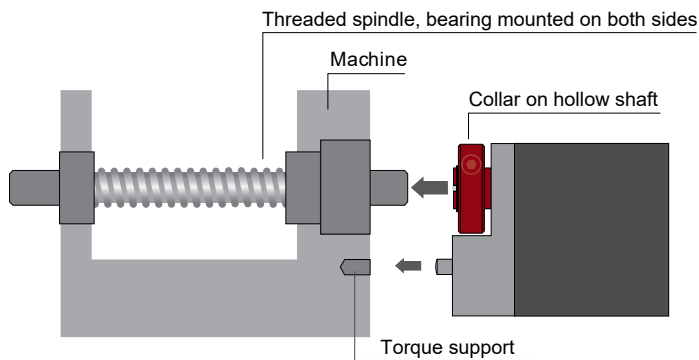



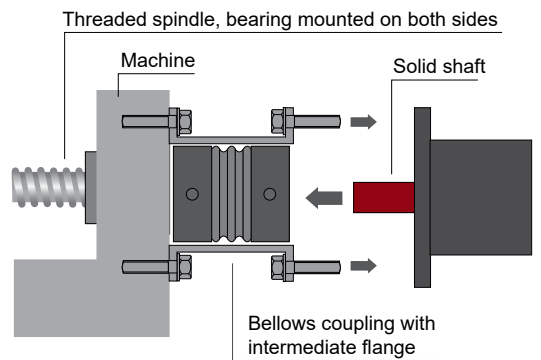

Mounting with solid shaft and coupling



Positioning System PSD

41 - 3-14H - 2 - CA - 0 - 50 - 1 - 0

Type

- 40: Horizontal 
- 41: Vertical 
- 42: Horizontal 
- 43: Vertical 

Torque (see table)

- 1 Nm
- 2 Nm
- 3 Nm
- 6 Nm
- 8 Nm

Output shaft ø mm (see table)

- 5
- 8
- 14

Shaft type (see table)

- V: Solid
- H: Hollow

Rotation shaft / Housing (see table)

- S: Direct or 0°
- 1: 90°
- 2: 180°
- 3: 270°

Bus communication

- CA: CANopen
- IO: IO-Link
- PN: PROFINET
- EC: EtherCAT
- EI: EtherNet / IP

Electrical connections

- 0: Standard2

Protection class

- 50: IP50
- 65: IP653

Software modules

- 1: Standard
- M: With modulo function4
- S: With changeover of parameter set4
- P: With target speed in process data4
- Z: With modulo function and changeover of parameter set and target speed in process data

Certificates

- 0: CE + UKCA

1 For CANopen and IO-Link, others on request.
 2 Standard equipment: 3 plugs / sockets with IO-Link: 1 plug.
 3 IP 65 installed (motor shaft IP 50).
 4 Only for IO-Link devices.

Type PSD 40 & 41

Key		Torque	Output shaft	Rotation shaft / Housing
1-5V	Direct	1 = 0,8 Nm	5V = 5 mm solid shaft	S: Direct or 0°
1-8H 1-14H	Direct	1 = 0,8 Nm	8H = 8 mm hollow shaft 14H = 14 mm hollow shaft	S: Direct or 0° 1: 90° 2: 180° 3: 270°
3-8H 3-14H	With gearbox	3 = 3 Nm	8H = 8 mm hollow shaft 14H = 14 mm hollow shaft	S: Direct or 0° 1: 90° 2: 180° 3: 270°

Type PSD 42 & 43

Key		Torque	Output shaft	Rotation shaft / Housing
2-8V	Direct	2 = 2 Nm	8V = 8 mm solid shaft	S: Direct or 0°
2-8H 2-14H	Direct	2 = 2 Nm	8H = 8 mm hollow shaft 14H = 14 mm hollow shaft	S: Direct or 0° 1: 90° 2: 180° 3: 270°
6-14H	With gearbox	6 = 6 Nm	14H = 14 mm hollow shaft	S: Direct or 0° 1: 90° 2: 180° 3: 270°
8-14H	With gearbox	8 = 8 Nm	14H = 14 mm hollow shaft	S: Direct or 0° 1: 90° 2: 180° 3: 270°





Positioning System PSE/PSS/PSW

PSE - 302-8V - CA - 0 - 0 - 0 - 54

Design

PSE (Effecient)
 PSS (Stainless)
 PSW (Washable)

Type

30: Horizontal 
 31: Vertical 
 32: Horizontal 
 33: Vertical 
 34: Horizontal 1 

Torque (see table)

1 Nm
 2 Nm
 5 Nm
 10 Nm
 18 Nm
 25 Nm 1

Output shaft ø mm (see table)

8
 14

Shaft type (see table)

V: Solid10
 H: Hollow

Bus communication

CA: CANopen	EC: EtherCAT
DP: PROFIBUS DP	PN: PROFINET
DN: DeviceNet2	EI: EtherNet/IP
MB: Modbus RTU2	PL: POWERLINK
SE: Sercos	IO: IO-Link

Electrical connections

O: Standard
 T: Standard with jog keys3,4
 Y: Plug-in, Y-encoded2
 Z: Plug-in, Y-encoded with jog keys2, 3

Brake

O: Without
 M: With5

Certification

O: CE
 N: NRTL + CE
 S: STO + CE without test pulses6
 T: STO + CE with test pulses6
 Y: STO + NRTL without test pulses6
 Z: STO + NRTL with test pulses6

Protection class

54: IP547
 65: IP658
 68: IP689

- ¹ Only for PSE.
- ² Not for PSE 34.
- ³ Not for PSE 31.
- ⁴ Always via an extra connector plug, not for IO-Link or PSW.
- ⁵ Only 14 mm output shafts
- ⁶ Only for IP 65. Not for PSE 34. Only for EtherCAT, PROFINET, EtherNet / IP, only on request.
- ⁷ Only for PSE, PSE 34, only IP 65.
- ⁸ For PSS. For PSE 30 / 31 / 32 / 33 on request.
- ⁹ Only for PSW
- ¹⁰ Not available for PSE

Standard equipment (connections)

- Always provided with 3 plugs/sockets (not for IO-Link or Y-encoded connector)
- Address switches always provided (also IE-buses, not for IO-Link)

Design	Key	Torque	Output shaft
PSE PSS PSW	30 1-8 2-8 5-8 1-14 2-14 5-14	1 = 1 Nm 2 = 2 Nm 5 = 5 Nm	8 = 8 mm hollow shaft 8V = 8 mm solid shaft 8H = 8 mm hollow shaft 14 = 14 mm hollow shaft 14V = 14 mm solid shaft 14H = 14 mm hollow shaft
PSE PSS PSW	31 1-8 2-8 5-8 1-14 2-14	1 = 1 Nm 2 = 2 Nm 5 = 5 Nm	8 = 8 mm hollow shaft 8V = 8 mm solid shaft 8H = 8 mm hollow shaft 14 = 14 mm hollow shaft 14V = 14 mm solid shaft 14H = 14 mm hollow shaft
PSE PSS PSW	32 2-14 5-14 10-14 18-14	2 = 2 Nm 5 = 5 Nm 10 = 10 Nm 18 = 18 Nm	14 = 14 mm hollow shaft 14V = 14 mm solid shaft 14H = 14 mm hollow shaft
PSE PSS PSW	33 2-14 5-14 10-14 25-14	2 = 2 Nm 5 = 5 Nm 10 = 10 Nm 25 = 25 Nm	14 = 14 mm hollow shaft 14V = 14 mm solid shaft 14H = 14 mm hollow shaft
PSE	34 10-14 18-14	10 = 10 Nm 18 = 18 Nm	14 = 14 mm hollow shaft

**ALWAYS THE RIGHT
SOLUTION AT THE RIGHT TIME.**

ROLLCO

LINEAR SOLUTIONS **YOUR** WAY

With reliability, competence and commitment Rollco rapidly delivers the right solutions and components to create safe and cost-effective automation and linear movement.

Rollco AB

Box 22234
Ekvändan 3
250 24 Helsingborg
Sweden
Tel. +46 42 15 00 40
www.rollco.se

Rollco A/S

Skomagervej 13 E
7100 Vejle
Denmark
Tel. +45 75 52 26 66
www.rollco.dk

Rollco Oy

Sarankulmankatu 12
33900 Tampere
Finland
Tel. +358 207 57 97 90
www.rollco.fi

Rollco Norge AS

Industrigata 6
3414 Lierstrada
Norway
Tel. +47 32 84 00 34
www.rollco.no