

TECHNICAL INFORMATION

ALUMINIUM PROFILE

SYSTEM 30 - SLOT 6

SYSTEM 20 - SLOT 5



Information in this document is subject to change. Owing to continued product development, Rollco reserves the right to make alterations without prior notice. Every care has been taken to ensure the accuracy of the information, but no liability can be accepted for any errors or omissions.

All information and content included in this document, such as text, and images, are property of Rollco. Any reproduction, even partial, is allowed only by written permission by Rollco.

Aluminium Profile Overview

System 30 - Slot 6

The profile is designed for any kind of construction with optimised weight. The range includes two versions, Standard and Light.

- T-slot 6
- Center hole for M6

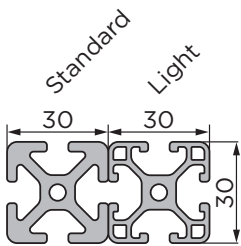

System 20 - Slot 5

The profile has small outer dimensions which particularly fit compact equipment with minor design space requirements, covers and handling mechanisms.

- T-slot 5
- Center hole for M5

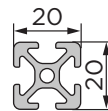

System 30 - Slot 6 Normal

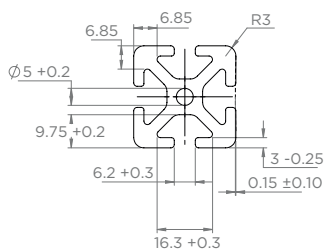
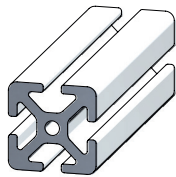

System 30 - Slot 6 Light

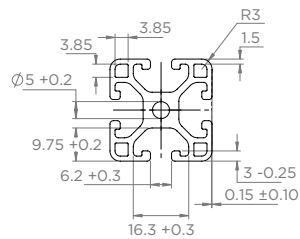
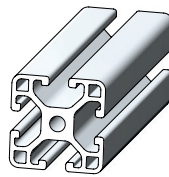

System 20 - Slot 5

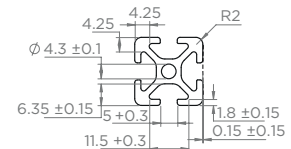
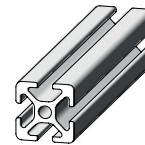

Mechanical Data

(Values in direction of press.)

- **EN AW - 6063:** Material number pursuant to DIN EN 573
- **Rm:** 245 N/mm² (minimum tensile strength)
- **Rp 0.2:** 195 N/mm² (yield strength)
- **A5:** 10% (elongation at break)
- **A10:** 8% (elongation at break)
- **E:** Approx. 70,000 N/mm² (modulus of elasticity)
- **HB:** Approx. 75 (Brinell hardness)
- **a:** 23.4 × 10⁻⁶ 1/K (coefficient of linear expansion)
- **Tolerances:** DIN EN 12020-2
- **Eloxal:** E6EV1
- **Coating thickness:** 10-15 μm
- **RAL colours powder coating (on request)**

Manufacturing Tolerances

Tolerances Of External Dimensions and T-Slot Positions

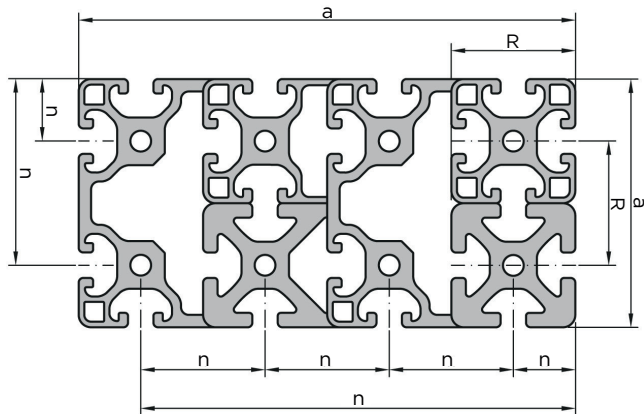

Width H (mm)		Tolerances of external dimension H or rather t-slot position N ± (mm)
over	to	
0	10	0.10
10	20	0.15
20	40	0.20
40	60	0.30
60	80	0.40
80	100	0.45
100	120	0.50
120	160	0.60
160	240	0.80

T-Slot Dimension Tolerances

The profiles possess a standardised t-slot shape. This guarantees that all fasteners and accessories can be utilised with the different profile series and sizes.

	System 30 - Slot 6	System 20 - Slot 5
Spacing R	R: 30 mm	R: 20 mm

Center Holes

The center hole bore of the profiles can be opened up according to the table.

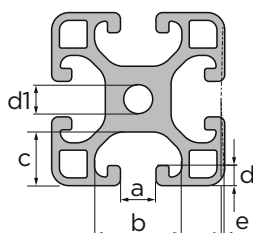

	System 30 - Slot 6	System 20 - Slot 5
a	6.2 +0.3/-0	5.0 +0.3/-0
b	16.3 +0.3/-0	11.5 +0.3/-0
c	9.75 +0.2/-0	6.35 ±0.15
d	3.0 +0/-0.25	1.8 ±0.15
e	0.15 ±0.1	0.15 ±0.1
d1	5.0 +0.2/-0.1	4.3 ±0.1

Load capacity of profile slot

Tensile stress

Static stress limit of slot (when deformation sets in) if connectors with largest thread are used:

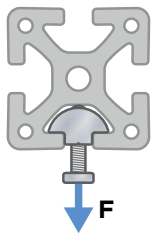

Nut	Profile	Pivoting slot nut
5	I5 2020	1,000 N
6	I6 3030	3,500 N
6	I6 3030L	1,000 N

Note: The above stress limits have been determined on samples subjected to pull-out tests. Safety factors have not been taken into account. Separately consider statutory regulations and the relevant codes of practice.

Torsion

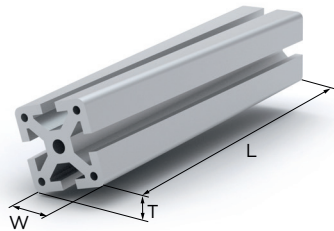

Width W (mm)		Torsion tolerance T (mm) for nominal length L (mm)					
over	to	to 1000	to 2000	to 3000	to 4000	to 5000	to 6000
-	25	1.0	1.5	1.5	2.0	2.0	2.0
25	50	1.0	1.2	1.5	1.8	2.0	2.0
50	75	1.0	1.2	1.2	1.5	2.0	2.0
75	100	1.0	1.2	1.5	2.0	2.2	2.5
100	125	1.0	1.5	1.8	2.2	2.5	3.0
125	150	1.2	1.5	1.8	2.2	2.5	3.0
150	200	1.5	1.8	2.2	2.6	3.0	3.5
200	300	1.8	2.5	3.0	3.5	4.0	4.5

Straightness Tolerance

Longitudinal

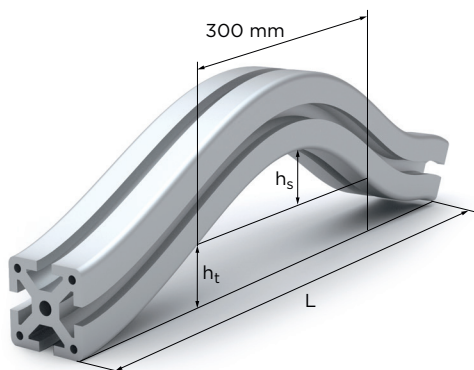

Length L (mm)	Straightness tolerance h_t for nominal length L (mm)
to 1000	0.7
to 2000	1.3
to 3000	1.8
to 5000	2.2
to 5000	2.6
to 6000	3.0

The straightness tolerance h_t is in relation to a corresponding length L and will not exceed the stated value in the table. The straightness tolerance h_s will not exceed 0.3 mm per 300 mm in length.

Bending/Calculation

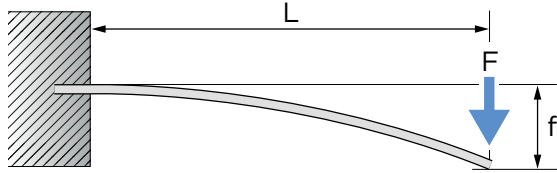

$$f = \frac{F \times L^3}{3E \times I \times 10^4}$$

Profile bending caused by force F

$$f = \frac{m \times g \times L^4}{8E \times I \times 10^4}$$

Profile bending caused by the profile's own weight

$$\delta = \frac{(m \times g \times L + F) \times L}{W \times 10^3}$$

Control of bending stress

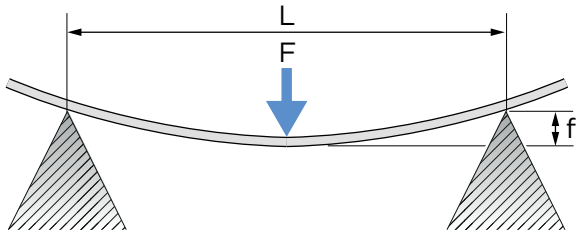

$$f = \frac{F \times L^3}{48 \times E \times I \times 10^4}$$

Profile bending caused by force F

$$f = \frac{5 \times m \times g \times L^4}{384E \times I \times 10^4}$$

Profile bending caused by the profile's own weight

$$\delta = \frac{(m \times g \times L + F) \times L}{4W \times 10^3}$$

Control of bending stress

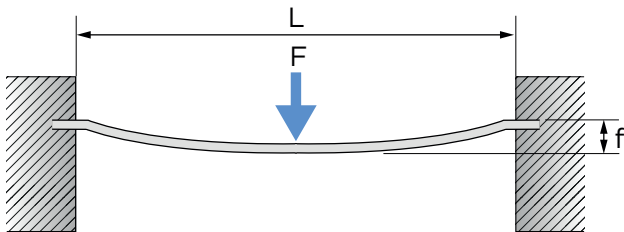

$$f = \frac{F \times L^3}{192E \times I \times 10^4}$$

Profile bending caused by force F

$$f = \frac{m \times g \times L^4}{384E \times I \times 10^4}$$

Profile bending caused by the profile's own weight

$$\delta = \frac{(m \times g \times L + F) \times L}{8W \times 10^3}$$

Control of bending stress

- f = bending (mm)
- F = force (N)
- L = profile length (mm)
- E = modulus of elasticity (70,000 N/mm²)
- g = fall velocity (9.81 m/s²)
- m = mass (kg/mm)
- I = moment of inertia (cm⁴)
- W = section modulus (cm³)

**ALWAYS THE RIGHT
SOLUTION AT THE RIGHT TIME.**

ROLLCO

LINEAR SOLUTIONS **YOUR WAY**

With reliability, competence and commitment Rollco rapidly delivers the right solutions and components to create safe and cost-effective automation and linear movement.

Rollco AB

Box 22234
Ekvändan 3
250 24 Helsingborg
Sweden
Tel. +46 42 15 00 40
www.rollco.se

Rollco A/S

Skomagervej 13 E
7100 Vejle
Denmark
Tel. +45 75 52 26 66
www.rollco.dk

Rollco Oy

Sarankulmankatu 12
33900 Tampere
Finland
Tel. +358 207 57 97 90
www.rollco.fi

Rollco Norge AS

Industrigata 6
3414 Lierstrada
Norway
Tel. +47 32 84 00 34
www.rollco.no